



TM70P02DF

P-Channel Enhancement Mosfet

<p>General Description</p> <ul style="list-style-type: none"> • Low $R_{DS(ON)}$ • RoHS and Halogen-Free Compliant <p>Applications</p> <ul style="list-style-type: none"> • Load switch • PWM 	<p>General Features</p> <p>$V_{DS} = -20V$ $I_D = -70A$ $R_{DS(ON)} = 4.5m\Omega$(typ.) @ $V_{GS} = -4.5V$</p> <p>100% UIS Tested 100% R_g Tested</p> 
--	---

DF:PDFN3x3-8L

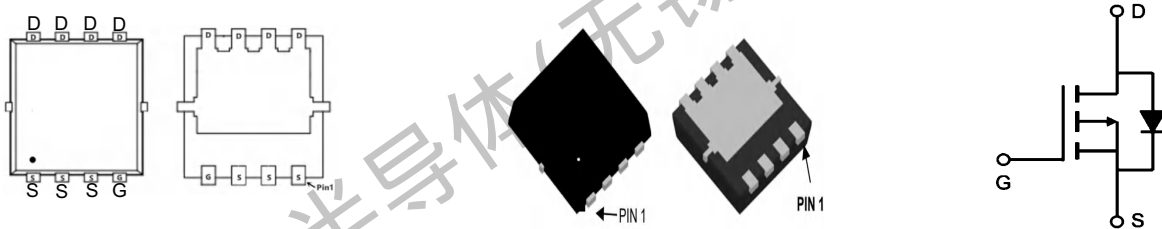

Marking: 70P02

Absolute Maximum Ratings ($T_C=25^\circ C$ unless otherwise noted)

Symbol	Parameter	Rating	Units
V_{DS}	Drain-Source Voltage	-20	V
V_{GS}	Gate-Source Voltage	± 12	V
$I_D@T_C=25^\circ C$	Continuous Drain Current, $-V_{GS}$ @ $-4.5V^1$	-70	A
$I_D@T_C=100^\circ C$	Continuous Drain Current, $-V_{GS}$ @ $-4.5V^1$	-45.5	A
I_{DM}	Pulsed Drain Current ²	-259	A
EAS	Single Pulse Avalanche Energy ²	68	mJ
P_D	Total Power Dissipation ⁴	23	W
T_{STG}	Storage Temperature Range	-55 to 175	$^\circ C$
T_J	Operating Junction Temperature Range	-55 to 175	$^\circ C$

Thermal Data

Symbol	Parameter	Typ.	Max.	Unit
$R_{\theta JA}$	Thermal Resistance Junction-Ambient ¹	---	62	$^\circ C/W$
$R_{\theta JC}$	Thermal Resistance Junction-Case ¹	---	3.6	$^\circ C/W$



TM70P02DF

P-Channel Enhancement Mosfet

Electrical Characteristics (T_J = 25°C, unless otherwise noted)

Symbol	Parameter	Conditions	Min	Typ	Max	Units
Off Characteristics						
BV_{DSS}	Drain-Source Breakdown Voltage	V _{GS} =0V, I _D =250 μ A	-20	---	---	V
I_{DSS}	Zero Gate Voltage Drain Current	V _{GS} =0V, V _{DS} =-20V	---	---	-1	μ A
I_{GSS}	Gate-Source Leakage Current	V _{GS} =±12V, V _{DS} =0A	---	---	±100	nA
On Characteristics						
V_{GS(th)}	GATE-Source Threshold Voltage	V _{GS} =V _{DS} , I _D =250 μ A	-0.4	-0.65	-1.0	V
R_{DS(on)}	Drain-Source On Resistance ⁴	V _{GS} =-4.5V, I _D =-10A	---	4.5	5.6	m Ω
		V _{GS} =-2.5V, I _D =-10A	---	5.9	7.6	m Ω
Dynamic Characteristics						
C_{iss}	Input Capacitance ⁵	V _{DS} =-10V, V _{GS} =0V, f=1MHz	---	4769	---	pF
C_{oss}	Output Capacitance ⁵		---	664	--	
C_{rss}	Reverse Transfer Capacitance ⁵		---	569	---	
Switching Characteristics						
t_{d(on)}	Turn-On Delay Time ⁵	V _{DS} =-10V, I _D =-10A, R _L =3 Ω, V _{GS} =-4.5V	---	21	---	ns
t_r	Rise Time ⁵		---	37	---	ns
t_{d(off)}	Turn-Off Delay Time ⁵		---	109	---	ns
t_f	Fall Time ⁵		---	61	---	ns
Q_g	Total Gate Charge ⁵		---	54	---	nc
Q_{gs}	Gate-Source Charge ⁵	V _{GS} =-4.5V, V _{DS} =-10V, I _D =-10A	---	5.1	---	nc
Q_{gd}	Gate-Drain "Miller" Charge ⁵		---	9	---	nc
Drain-Source Diode Characteristics						
V_{SD}	Diode Forward Voltage ⁴	V _{GS} =0V, I _{SD} =-10A	---	---	-1.2	V
I_S	Continuous Drain Current	VD=VG=0V	---	---	-70	A
I_{SM}	Pulsed Drain Current		---	---	-259	A

Notes:

1. Repetitive rating, pulse width limited by junction temperature T_{J(MAX)}=150°C.
2. The EAS data shows Max. rating. The test condition is V_{DD}= -25V, V_{GS}= -10V, L= 0.4mH, I_{AS}= -20A.
3. The data tested by surface mounted on a 1 inch² FR-4 board with 2OZ copper, The value in any given application depends on the user's specific board design.
4. The data tested by pulsed, pulse width ≤ 300us, duty cycle ≤ 2%.
5. This value is guaranteed by design hence it is not included in the production test.



TM70P02DF

P-Channel Enhancement Mosfet

Typical Characteristics

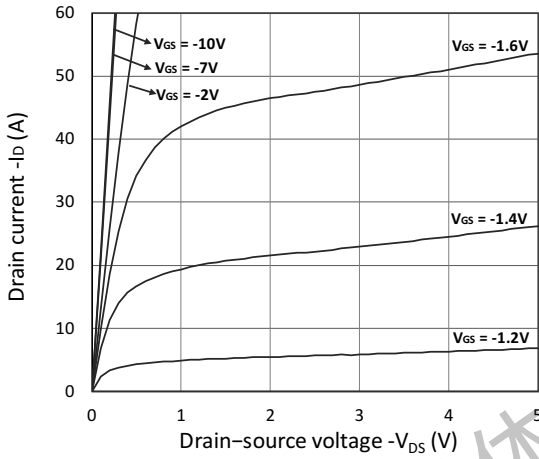

Figure 1. Output Characteristics

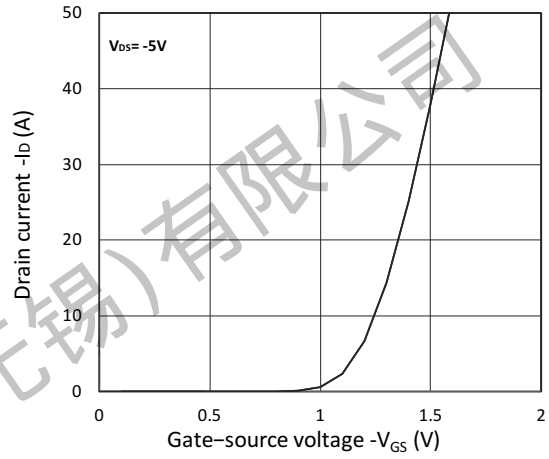

Figure 2. Transfer Characteristics

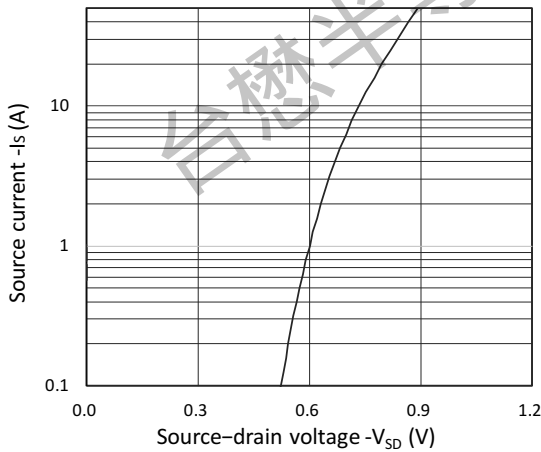

Figure 3. Forward Characteristics of Reverse

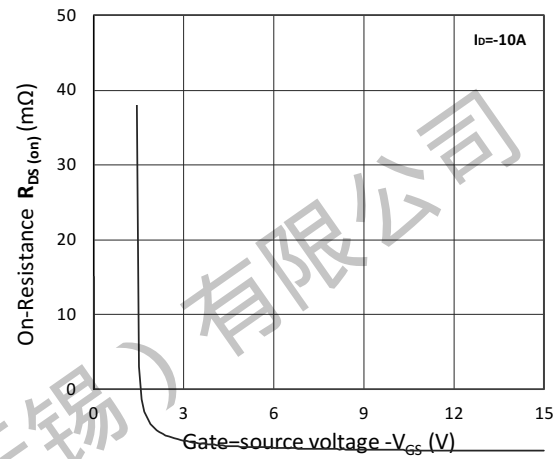

Figure 4. $R_{DS(ON)}$ vs. V_{GS}

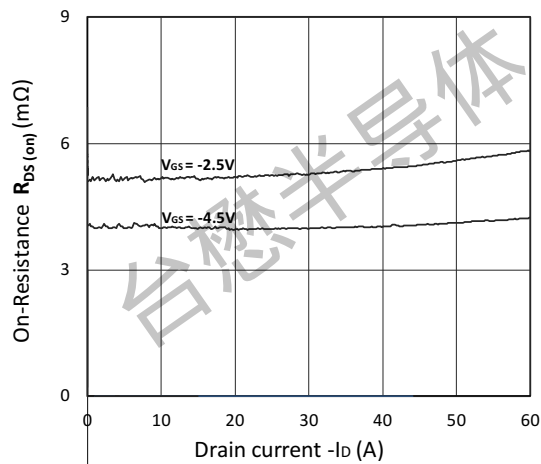

Figure 5. $R_{DS(ON)}$ vs. I_D

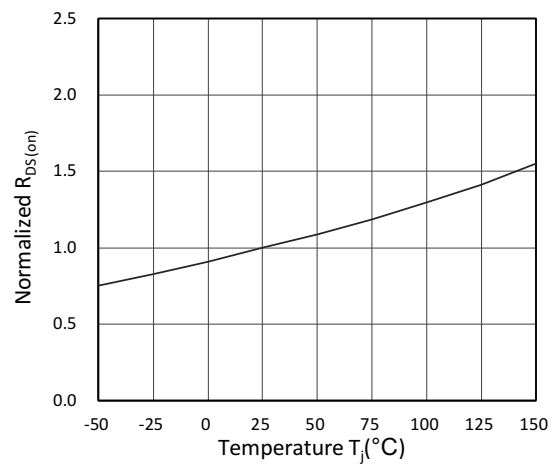

Figure 6. Normalized $R_{DS(ON)}$ vs. Temperature



TM70P02DF

P-Channel Enhancement Mosfet

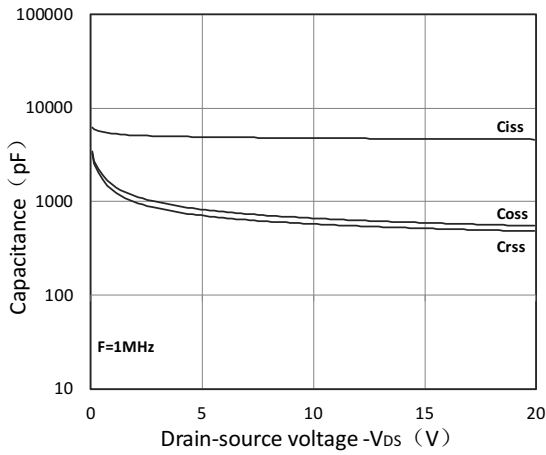

Figure 7. Capacitance Characteristics

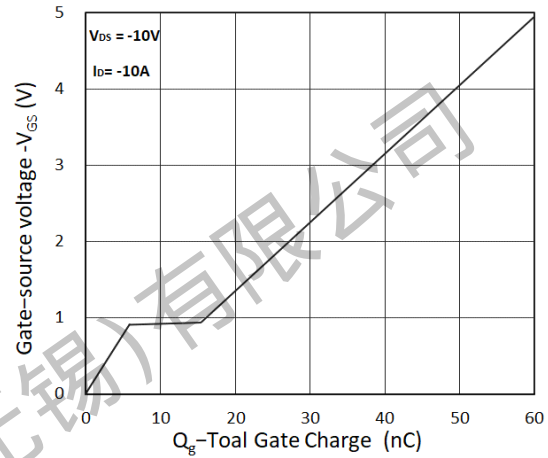

Figure 8. Gate Charge Characteristics

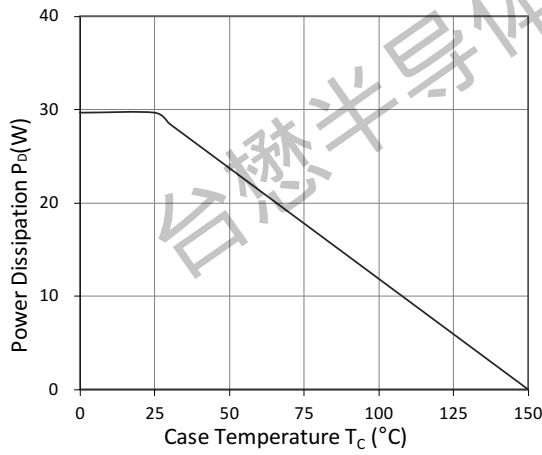

Figure 9. Power Dissipation

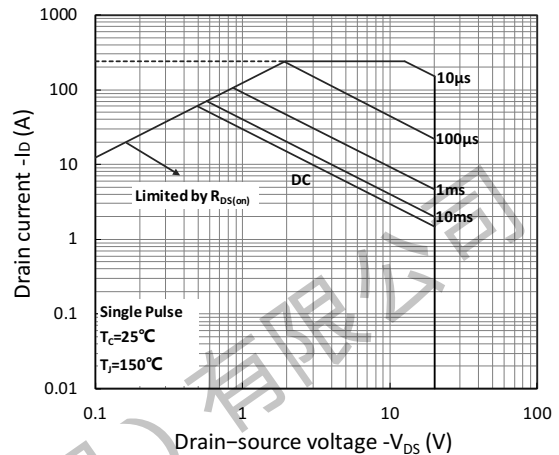

Figure 10. Safe Operating Area

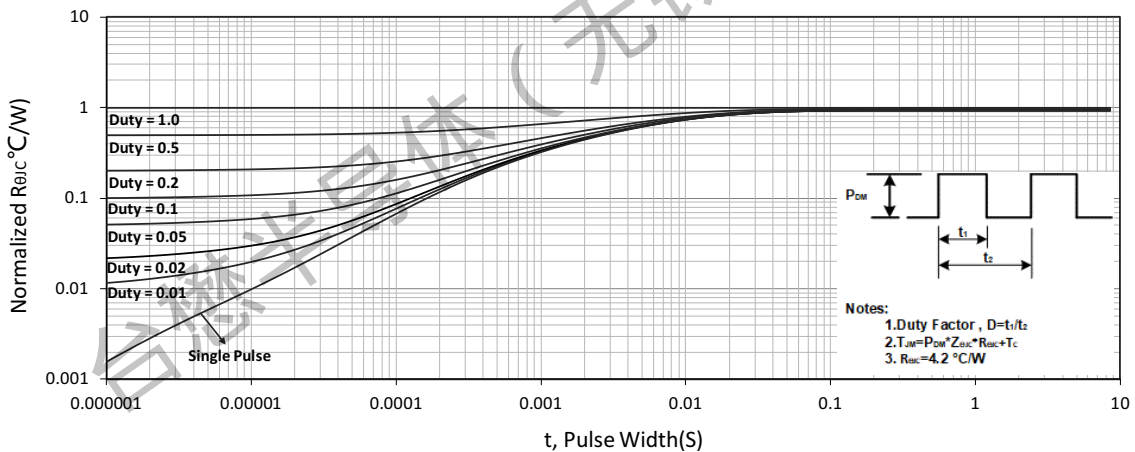
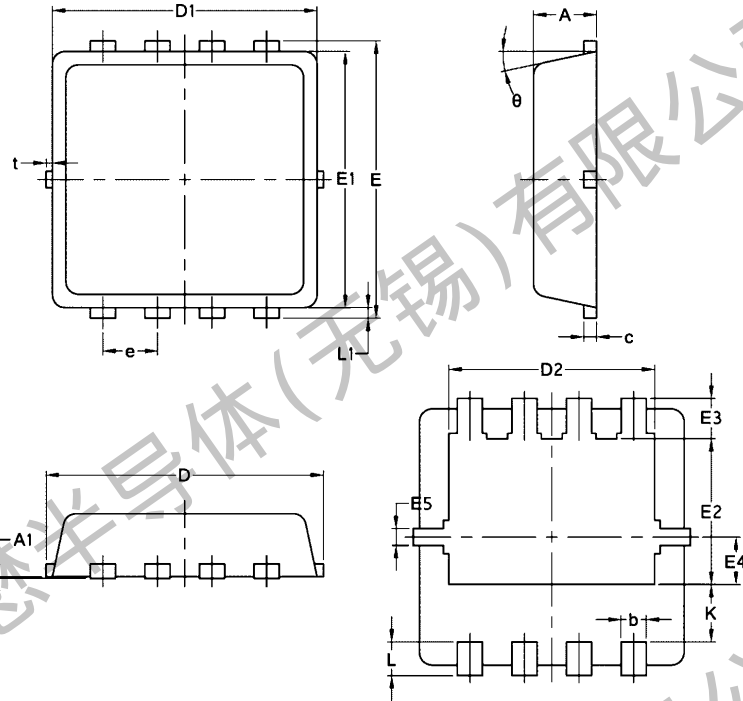

Figure 11. Normalized Maximum Transient Thermal Impedance

TM70P02DF

P-Channel Enhancement Mosfet

Package Mechanical Data:DFN3x3-8L



Symbol	Common		
	mm		
	Mim	Nom	Max
A	0.70	0.75	0.85
A1	/	/	0.05
b	0.20	0.30	0.40
c	0.10	0.152	0.25
D	3.15	3.30	3.45
D1	3.00	3.15	3.25
D2	2.29	2.45	2.65
E	3.15	3.30	3.45
E1	2.90	3.05	3.20
E2	1.54	1.74	1.94
E3	0.28	0.48	0.65
E4	0.37	0.57	0.77
E5	0.10	0.20	0.30
e	0.60	0.65	0.70
K	0.59	0.69	0.89
L	0.30	0.40	0.50
L1	0.06	0.125	0.20
t	0	0.075	0.13
Φ	10	12	14

TM70P02DF

P-Channel Enhancement Mosfet

PDFN3x3-8L Embossed Carrier Tape

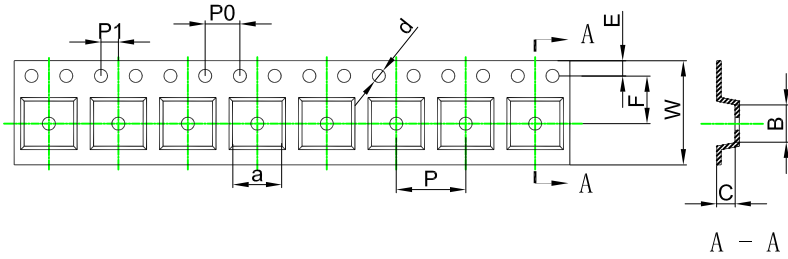

Packaging Description:
SOP-8L parts are shipped in tape. The carrier tape is made from a dissipative (carbon filled) polycarbonate resin. The cover tape is a multilayer film (Heat Activated Adhesive in nature) primarily composed of polyester film, adhesive layer, sealant, and anti-static sprayed agent. These reeled parts in standard option are shipped with 2,500 units per 13" or 33cm diameter reel. The reels are clear in color and is made of polystyrene plastic (anti-static coated).
ALL DIM IN mm

Dimensions are in millimeter										
Pkg type	a	B	C	d	E	F	P0	P	P1	W
PDFN3x3-8L	6.40	5.40	2.10	Ø1.50	1.75	5.50	4.00	8.00	2.00	12.00

PDFN3x3-8L Tape Leader and Trailer

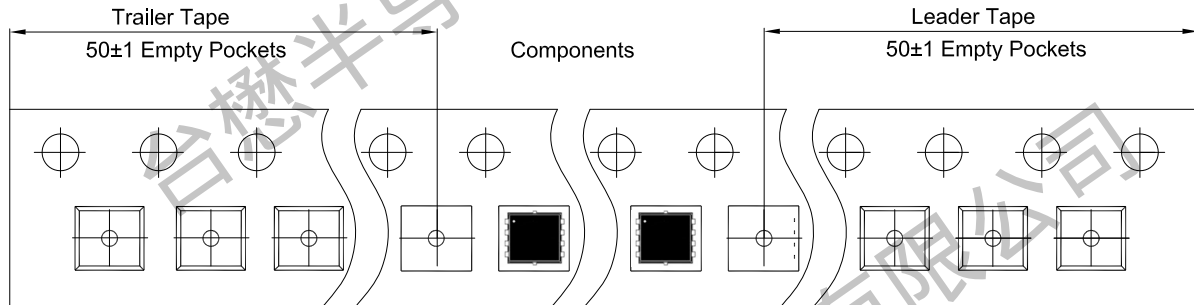

PDFN3x3-8L Reel

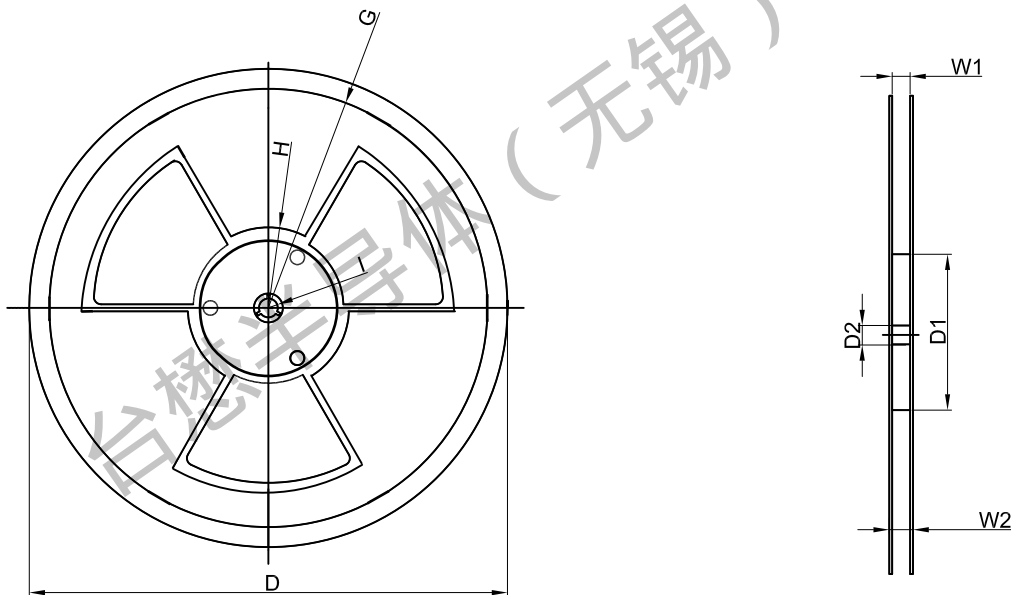

Dimensions are in millimeter								
Reel Option	D	D1	D2	G	H	I	W1	W2
13"Dia	Ø330.00	100.00	13.00	R135.00	R55.00	R6.50	12.00	14.00

REEL	Reel Size	Box	Box Size(mm)	Carton	Carton Size(mm)	G.W.(kg)
5,000 pcs	13 inch	10,000 pcs	370×355×52	50,000 pcs	400×360×368	



Important Notices and Disclaimers

- Tritech-MOS Technology Corp. reserves the right to change this document, its products, and specifications at any time without prior notice.
- Before final design, purchase, or use, customers should obtain and confirm the latest product information and specifications.
- Tritech-MOS Technology Corp. makes no warranties, representations or warranties regarding the suitability of its products for any specific purpose, and Tritech-MOS Technology Corp. does not assume any responsibility for application assistance or customer product design.
- Tritech-MOS Technology Corp. does not guarantee or assume any responsibility for the purchase or use of any unexpected or unauthorized products.
- Any intellectual property rights of Tritech-MOS Technology Corp. are not licensed through implicate or other means.
- Products of Tritech-MOS Technology Corp. are not included as critical components in life support equipment or systems without explicit written approval from Tritech-MOS Technology Corp.

Revision history:

Date	Rev	Description	Page
2023.09.19	23.09	Original	