

**TM06H06S**

**N+N-Channel Enhancement Mode Mosfet**

<p><b>General Description</b></p> <ul style="list-style-type: none"> <li>• Low <math>R_{DS(ON)}</math></li> <li>• RoHS and Halogen-Free Compliant</li> </ul> <p><b>Applications</b></p> <ul style="list-style-type: none"> <li>• Load switch</li> <li>• PWM</li> </ul>	<p><b>General Features</b></p> <p><math>V_{DS} = 60V</math> <math>I_D = 6.0A</math></p> <p><math>R_{DS(ON)} = 28m\Omega</math> (typ.) @ <math>V_{GS} = 10V</math></p> <p>100% UIS Tested 100% <math>R_g</math> Tested</p>
--	--



S:SOP-8L

Marking: 4828 OR 6946

**Absolute Maximum Ratings** ( $T_C = 25^\circ C$  Unless Otherwise Noted)

Symbol	Parameter	Rating	Units
$V_{DS}$	Drain-Source Voltage	60	V
$V_{GS}$	Gate-Source Voltage	$\pm 20$	V
$I_D @ T_C = 25^\circ C$	Continuous Drain Current, $V_{GS} @ 10V^1$	6.0	A
$I_D @ T_C = 70^\circ C$	Continuous Drain Current, $V_{GS} @ 10V^1$	4	A
$I_{DM}$	Pulsed Drain Current <sup>2</sup>	28	A
EAS	Single Pulse Avalanche Energy <sup>3</sup>	22	mJ
$I_{AS}$	Avalanche Current	23	A
$P_D @ T_A = 25^\circ C$	Total Power Dissipation <sup>3</sup>	1.5	W
$T_{STG}$	Storage Temperature Range	-55 to 150	$^\circ C$
$T_J$	Operating Junction Temperature Range	-55 to 150	$^\circ C$

**Thermal Data**

Symbol	Parameter	Typ.	Max.	Unit
$R_{\theta JA}$	Thermal Resistance Junction-ambient <sup>1</sup>	---	85	$^\circ C/W$
$R_{\theta JC}$	Thermal Resistance Junction-Case <sup>1</sup>	---	25	$^\circ C/W$



## TM06H06S

## N+N-Channel Enhancement Mode Mosfet

### Electrical Characteristics (T<sub>J</sub>=25°C unless otherwise specified)

Symbol	Parameter	Test Condition	Min.	Typ.	Max.	Units
<b>Off Characteristic</b>						
V <sub>(BR)DSS</sub>	Drain-Source Breakdown Voltage	V <sub>GS</sub> =0V, I <sub>D</sub> =250μA	60	-	-	V
I <sub>DSS</sub>	Zero Gate Voltage Drain Current	V <sub>DS</sub> =60V, V <sub>GS</sub> = 0V,	-	-	1.0	μA
I <sub>GSS</sub>	Gate to Body Leakage Current	V <sub>DS</sub> =0V, V <sub>GS</sub> = ±20V	-	-	±100	nA
<b>On Characteristics</b>						
V <sub>GS(th)</sub>	Gate Threshold Voltage	V <sub>DS</sub> =V <sub>GS</sub> , I <sub>D</sub> =250μA	1.0	2.0	3.0	V
R <sub>DS(on)</sub>	Static Drain-Source on-Resistance <small>note3</small>	V <sub>GS</sub> =10V, I <sub>D</sub> =5A	-	28	35	mΩ
		V <sub>GS</sub> =4.5V, I <sub>D</sub> =3A	-	36	50	
<b>Dynamic Characteristics</b>						
C <sub>iss</sub>	Input Capacitance	V <sub>DS</sub> =25V, V <sub>GS</sub> =0V, f=1.0MHz	-	948	-	pF
C <sub>oss</sub>	Output Capacitance		-	58.5	-	pF
C <sub>rss</sub>	Reverse Transfer Capacitance		-	49.4	-	pF
Q <sub>g</sub>	Total Gate Charge	V <sub>DS</sub> =30V, I <sub>D</sub> =2.5A, V <sub>GS</sub> =10V	-	20.3	-	nC
Q <sub>gs</sub>	Gate-Source Charge		-	3.7	-	nC
Q <sub>gd</sub>	Gate-Drain("Miller") Charge		-	5.3	-	nC
<b>Switching Characteristics</b>						
t <sub>d(on)</sub>	Turn-on Delay Time	V <sub>DS</sub> =30V, I <sub>D</sub> =5A, R <sub>G</sub> =1.8Ω, V <sub>GS</sub> =10V	-	7.6	-	ns
t <sub>r</sub>	Turn-on Rise Time		-	20	-	ns
t <sub>d(off)</sub>	Turn-off Delay Time		-	15	-	ns
t <sub>f</sub>	Turn-off Fall Time		-	24	-	ns
<b>Drain-Source Diode Characteristics and Maximum Ratings</b>						
I <sub>S</sub>	Maximum Continuous Drain to Source Diode Forward Current		-	-	6	A
I <sub>SM</sub>	Maximum Pulsed Drain to Source Diode Forward Current		-	-	20	A
V <sub>SD</sub>	Drain to Source Diode Forward Voltage	V <sub>GS</sub> =0V, I <sub>S</sub> =5A	-	-	1.2	V
t <sub>rr</sub>	Body Diode Reverse Recovery Time	I <sub>F</sub> =5A, dI/dt=100A/μs	-	29	-	ns
Q <sub>rr</sub>	Body Diode Reverse Recovery Charge		-	43	-	nC

Notes:1. Repetitive Rating: Pulse Width Limited by Maximum Junction Temperature

2. EAS condition : T<sub>J</sub>=25°C, V<sub>DD</sub>=30V, V<sub>G</sub>=10V, L=0.5mH, R<sub>G</sub>=25Ω, I<sub>AS</sub>=8.7A

3. Pulse Test: Pulse Width≤300μs, Duty Cycle≤0.5%



**TM06H06S**

**N+N-Channel Enhancement Mode Mosfet**

**Typical Performance Characteristics**

**Figure 1: Output Characteristics**

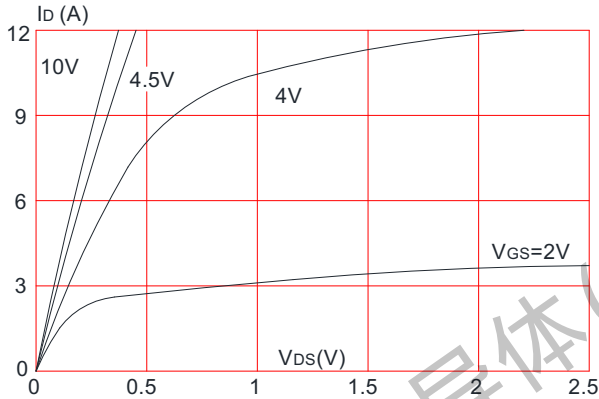

**Figure 2: Typical Transfer Characteristics**

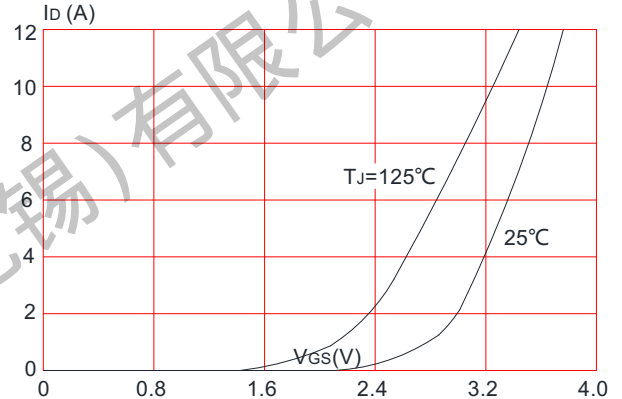

**Figure 3: On-resistance vs. Drain Current**

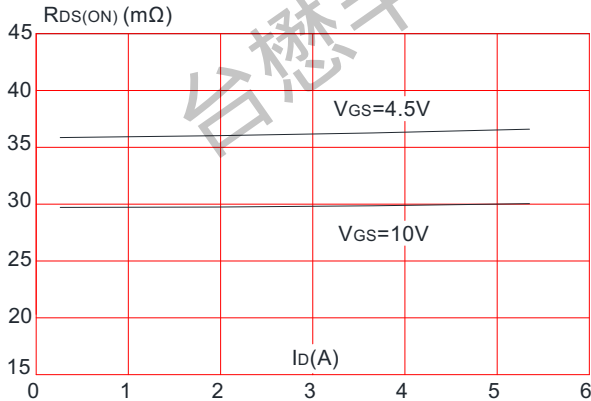

**Figure 4: Body Diode Characteristics**

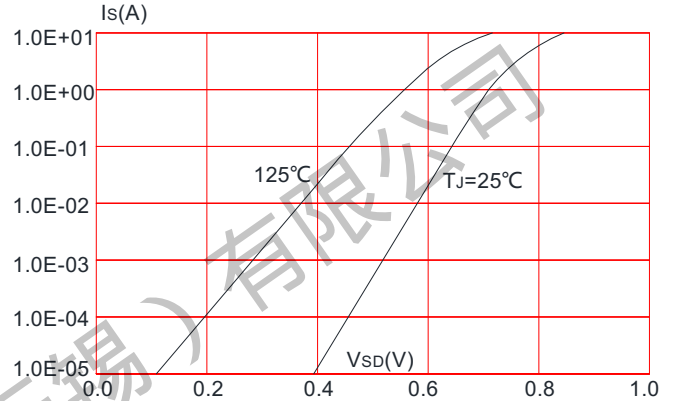

**Figure 5: Gate Charge Characteristics**

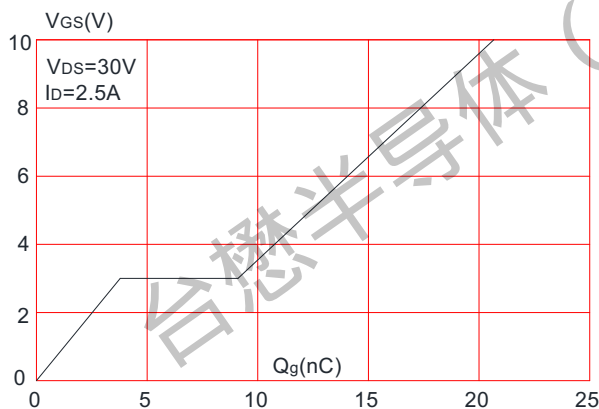

**Figure 6: Capacitance Characteristics**

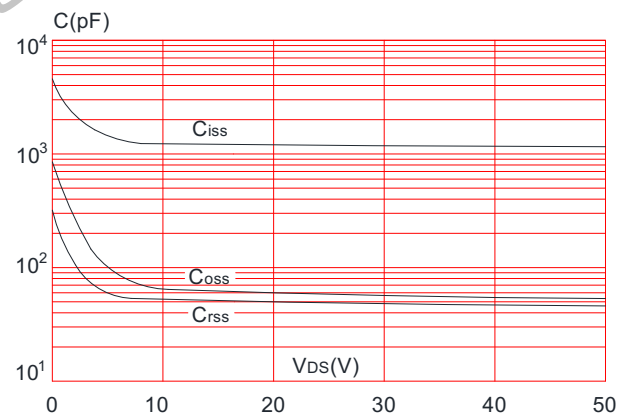

TM06H06S

N+N-Channel Enhancement Mode Mosfet

Figure 7: Normalized Breakdown Voltage vs. Junction Temperature

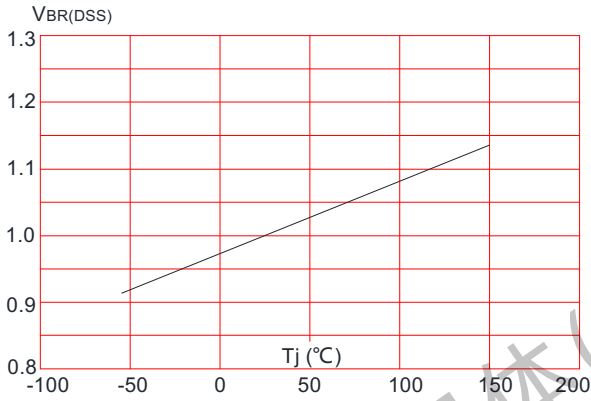

Figure 8: Normalized on Resistance vs. Junction Temperature

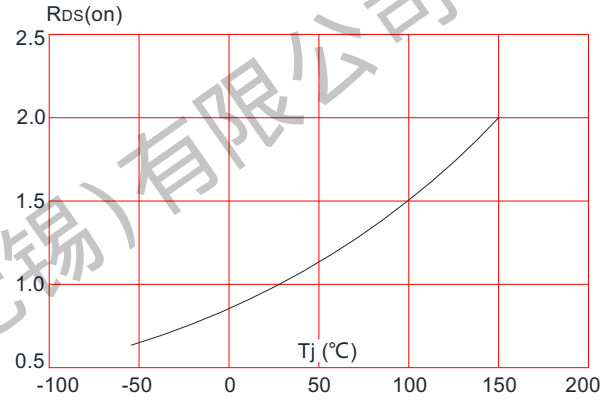

Figure 9: Maximum Safe Operating Area

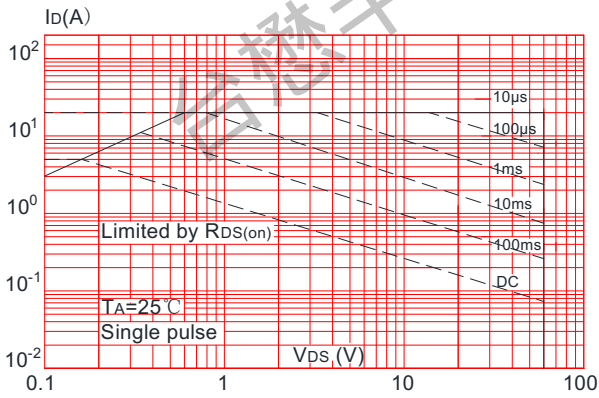

Figure 10: Maximum Continuous Drain Current vs. Ambient Temperature

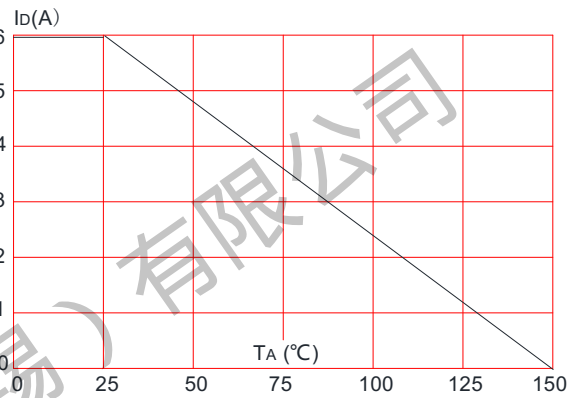
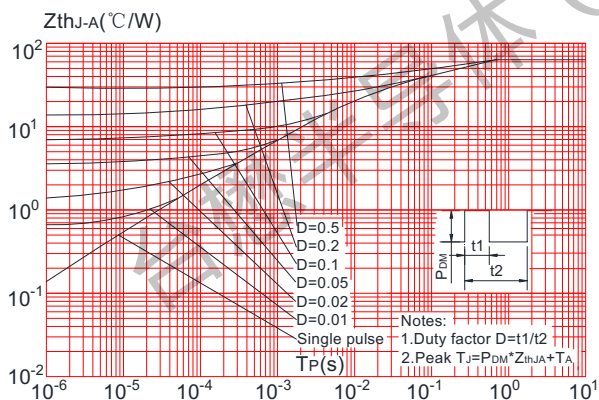

Figure.11: Maximum Effective Transient Thermal Impedance, Junction-to-Ambient



TM06H06S

N+N-Channel Enhancement Mode Mosfet

Package Mechanical Data:SOP-8L

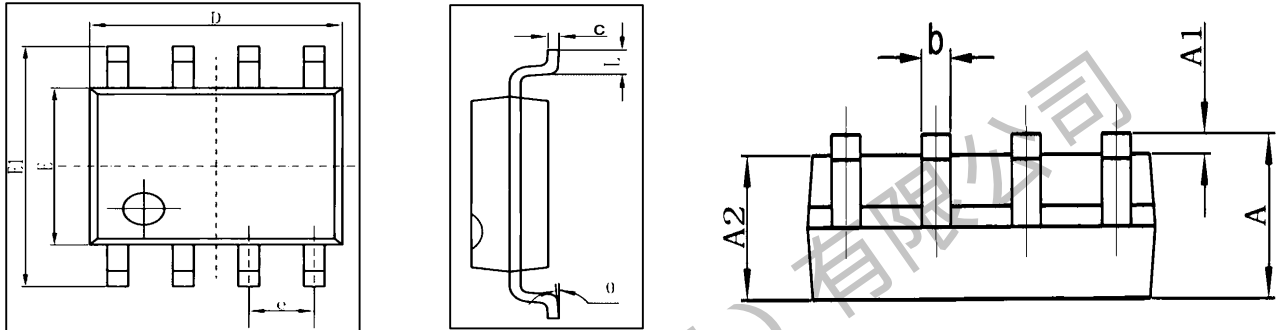

Symbol	Dimensions In Millimeters		Dimensions In Inches	
	Min	Max	Min	Max
A	1.350	1.750	0.053	0.069
A1	0.100	0.250	0.004	0.010
A2	1.350	1.550	0.053	0.061
b	0.330	0.510	0.013	0.020
c	0.170	0.250	0.006	0.010
D	4.700	5.100	0.185	0.200
E	3.800	4.000	0.150	0.157
E1	5.800	6.200	0.228	0.244
e	1.270 (BSC)		0.050 (BSC)	
L	0.400	1.270	0.016	0.050
θ	0°	8°	0°	8°

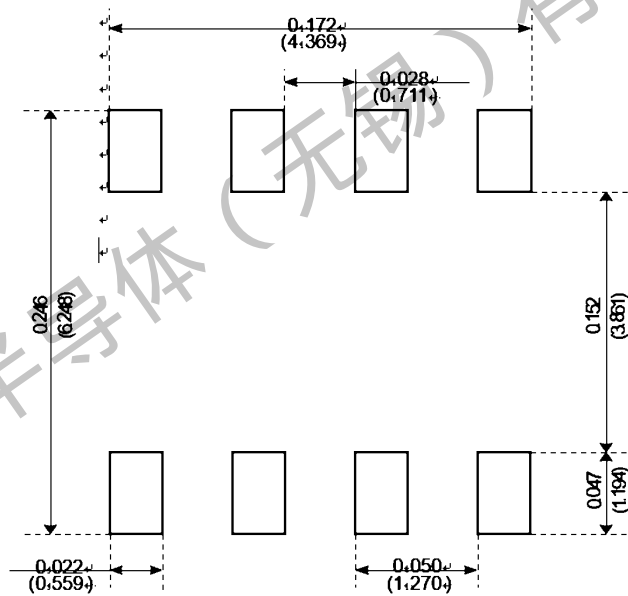

Recommended Minimum Pads

**TM06H06S**

**N+N-Channel Enhancement Mode Mosfet**

**SOP-8L Embossed Carrier Tape**

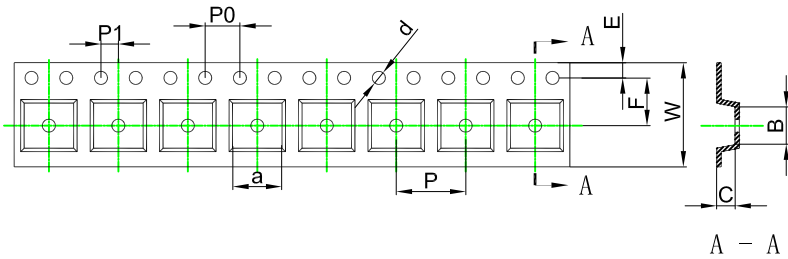

**Packaging Description:**

SOP-8L parts are shipped in tape. The carrier tape is made from a dissipative (carbon filled) polycarbonate resin. The cover tape is a multilayer film (Heat Activated Adhesive in nature) primarily composed of polyester film, adhesive layer, sealant, and anti-static sprayed agent. These reeled parts in standard option are shipped with 2,500 units per 13" or 33cm diameter reel. The reels are clear in color and is made of polystyrene plastic (anti-static coated).  
ALL DIM IN mm

Dimensions are in millimeter										
Pkg type	a	B	C	d	E	F	P0	P	P1	W
SOP-8L	6.40	5.40	2.10	Ø1.50	1.75	5.50	4.00	8.00	2.00	12.00

**SOP-8L Tape Leader and Trailer**

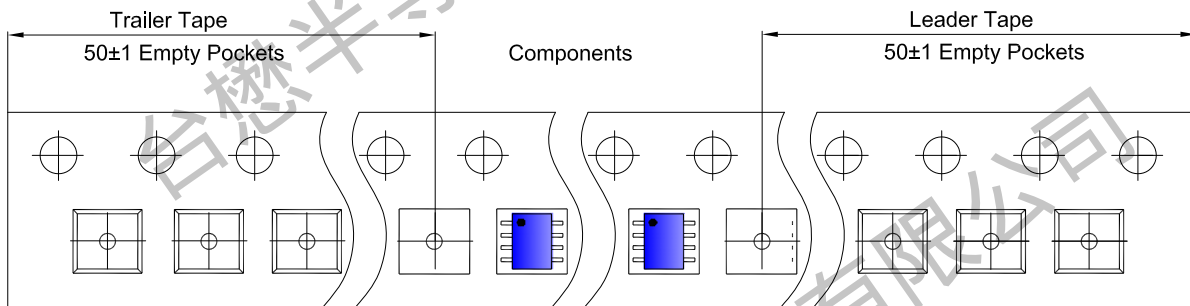

**SOP-8L Reel**

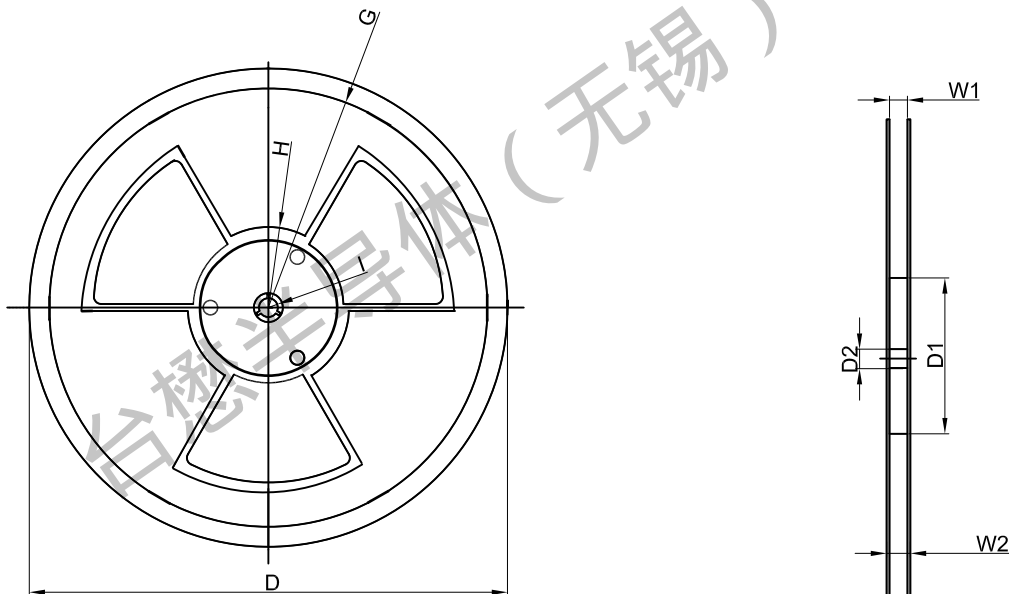

Dimensions are in millimeter								
Reel Option	D	D1	D2	G	H	I	W1	W2
13" Dia	Ø330.00	100.00	13.00	R135.00	R55.00	R6.50	12.00	14.00

REEL	Reel Size	Box	Box Size(mm)	Carton	Carton Size(mm)	G.W.(kg)
3,000 pcs	13 inch	6,000 pcs	370×355×52	48,000 pcs	400×360×368	

### Important Notices and Disclaimers

- Tritech-MOS Technology Corp. reserves the right to change this document, its products, and specifications at any time without prior notice.
- Before final design, purchase, or use, customers should obtain and confirm the latest product information and specifications.
- Tritech-MOS Technology Corp. makes no warranties, representations or warranties regarding the suitability of its products for any specific purpose, and Tritech-MOS Technology Corp. does not assume any responsibility for application assistance or customer product design.
- Tritech-MOS Technology Corp. does not guarantee or assume any responsibility for the purchase or use of any unexpected or unauthorized products.
- Any intellectual property rights of Tritech-MOS Technology Corp. are not licensed through implicate or other means.
- Products of Tritech-MOS Technology Corp. are not included as critical components in life support equipment or systems without explicit written approval from Tritech-MOS Technology Corp.

Revision history:

Date	Rev	Description	Page
2023.06.26	23.06	Original	